



EF..M type directional solenoid valves - 2 way / 2 positions

- Pilot operated
- Poppet type
- Oil leakage free from port 1 to port 2
- Normally open and closed configurations
- From SAE08 to SAE16 cavities

Technical specifications and diagrams are measured with mineral oil of 46 cSt viscosity at 40°C (104°F) temperature.

		EF08M	EF10M	EF12M	EF16M
Nominal flow		40 l/min (10.5 US gpm)	70 l/min (18.5 US gpm)	150 l/min (40 US gpm)	150 l/min (40 US gpm)
Max. pressure		380 bar (5500 psi)			
Oil leakage	at 210 bar (3050 psi)	0.50 cm ³ /min (0.030 in ³ /min)	0.50 cm ³ /min (0.030 in ³ /min)	0.50 cm ³ /min (0.030 in ³ /min)	0.50 cm ³ /min (0.030 in ³ /min)
Fluid		mineral based oil			
Viscosity		10-200 cSt			
Max level of contamination		18/16/13 ISO4406			
Fluid temperature	with NBR seals with FPM seals	from -20°C (-4°F) to 80°C (176°F) from -20°C (-4°F) to 100°C (212°F)			
Environmental temp. for working conditions		from -20°C (-4°F) to 50°C (122°F)			
Cavity		SAE 08/2	SAE 10/2	SAE 12/2	SAE 16/2
Coil type*		BER			
Nominal voltages		12 VDC - 24 VDC ± 10%			
Power rating		22.8 W (12 VDC) - 22.5 W (24 VDC)			
Weight		0.135 kg (0.30 lb)	0.170 kg (0.37 lb)	0.230 kg (0.51 lb)	0.315 kg (0.69 lb)

NOTE - For different conditions, please contact Walvoil Sales Dpt. - *For coils further features see from page 206.

Normally open configuration

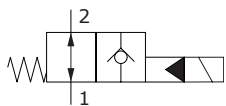

Normally closed configuration

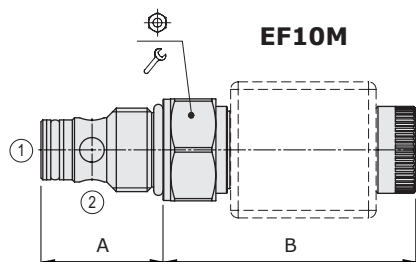
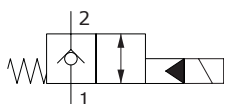

Valve type	A		B				Nm	lbft
	mm	in	mm	in				
EF08M/	10NB	28	1.10	67.2	2.64	24	30	22
	20NB	28	1.10	63.3	2.49	24	30	22
EF10M/	10NB	32.3	1.27	66.9	2.63	27	50	37
	20NB	32.3	1.27	63	2.48	27	50	37
EF12M/	10NB	45	1.77	61.1	2.40	32	80	59
	20NB	45	1.77	57.2	2.25	32	80	59
EF16M/	10NB	46	1.81	61.2	2.41	38	80	59
	20NB	46	1.81	57.3	2.26	38	80	59

For dimensions with different type of emergency see page 213

Ordering codes and description composition

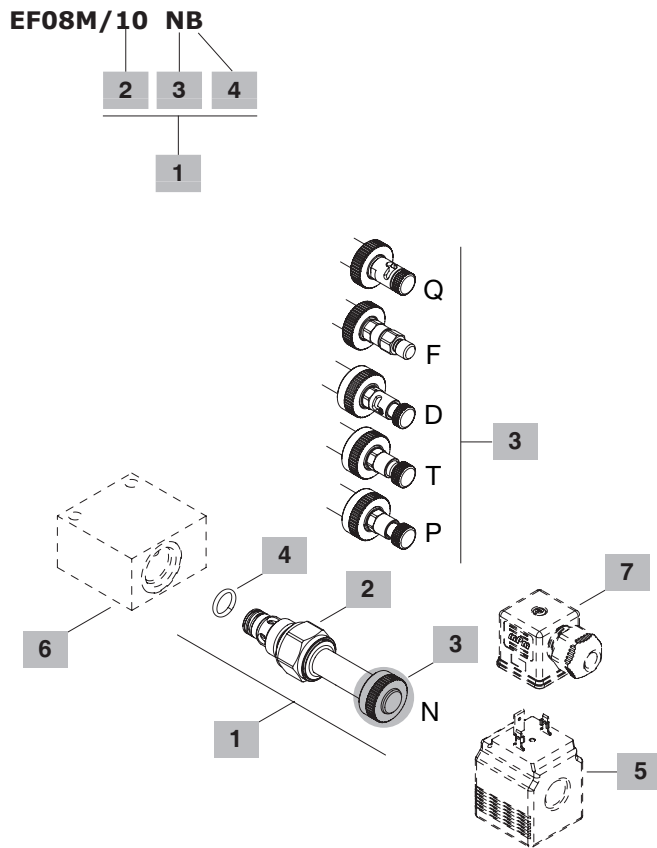

1 Cartucce

TYPE	CODE	DESCRIPTION
SAE cavity 08/2		
EF08M/10NB	0EF08002000	Normally open (N.O.) without emergency
EF08M/10PB	0EF08002002	(N.O.) push button emergency
EF08M/10TB	0EF08002003	(N.O.) screw type emergency
EF08M/10DB	0EF08002004	(N.O.) push type with detent emergency
EF08M/20NB	0EF08002001	Normally closed (N.C.) without emergency
EF08M/20FB	0EF08002005	(N.C.) pull button emergency
EF08M/20TB	0EF08002006	(N.C.) screw type emergency
EF08M/20QB	0EF08002007	(N.C.) pull type with detent emergency
SAE cavity 10/2		
EF10M/10NB	0EF10002000	Normally open (N.O.) without emergency
EF10M/10PB	0EF10002002	(N.O.) push button emergency
EF10M/10TB	0EF10002003	(N.O.) screw type emergency
EF10M/10DB	0EF10002004	(N.O.) push type with detent emergency
EF10M/20NB	0EF10002001	Normally closed (N.C.) without emergency
EF10M/20FB	0EF10002005	(N.C.) pull button emergency
EF10M/20TB	0EF10002006	(N.C.) screw type emergency
EF10M/20QB	0EF10002007	(N.C.) pull type with detent emergency
SAE cavity 12/2		
EF12M/10NB	0EF12002000	Normally open (N.O.) without emergency
EF12M/10PB	0EF12002002	(N.O.) push button emergency
EF12M/10TB	0EF12002003	(N.O.) screw type emergency
EF12M/10DB	0EF12002004	(N.O.) push type with detent emergency
EF12M/20NB	0EF12002001	Normally closed (N.C.) without emergency
EF12M/20FB	0EF12002005	(N.C.) pull button emergency
EF12M/20TB	0EF12002006	(N.C.) screw type emergency
EF12M/20QB	0EF12002007	(N.C.) pull type with detent emergency
SAE cavity 16/2		
EF16M/10NB	0EF16002000	Normally open (N.O.) without emergency
EF16M/10PB	0EF16002002	(N.O.) push button emergency
EF16M/10TB	0EF16002003	(N.O.) screw type emergency
EF16M/10DB	0EF16002004	(N.O.) push type with detent emergency
EF16M/20NB	0EF16002001	Normally closed (N.C.) without emergency
EF16M/20FB	0EF16002005	(N.C.) pull button emergency
EF16M/20TB	0EF16002006	(N.C.) screw type emergency
EF16M/20QB	0EF16002007	(N.C.) pull type with detent emergency

2 Spool

TYPE	DESCRIPTION
1	Normally open configuration
2	Normally closed configuration

3 Emergency

TYPE	DESCRIPTION
N	Without emergency
P	Push button type (N.O.)
T	Screw type
D	Push type with detent (N.O.)
F	Pull button type (N.C.)
Q	Pull type with detent (N.C.)

4 Seals

TYPE	DESCRIPTION
B	NBR (Buna) o-ring seals, std configuration
V	FPM (Viton) o-ring seals, contact Sales Dept.

5 Coils

TYPE	CODE	DESCRIPTION
BER 12VDC	4SLE001200	12VDC-ISO4400 coil

For complete coils list see from page 206

6 Valve body

TYPE	CODE	DESCRIPTION
SAE 08/2-SAE8	3CC0820K11	Aluminium body for cavity 08 valve, SAE8 std thread
SAE 10/2-SAE8	3CC1020K11	Aluminium body for cavity 10 valve, SAE8 std thread
SAE 12/2-SAE10	3CC1220L11	Aluminium body for cavity 12 valve, SAE10 std thread
SAE 16/2-SAE12	3CC1620M11	Aluminium body for cavity 16 valve, SAE12 std thread

Note: aluminium body can stand up to 210 bar (3050 psi)
For steel bodies or different threading see from page 215

7 Connector

TYPE	CODE	DESCRIPTION
ISO4400	4CN1009995	Connector

For complete connectors list see from page 206

Rating diagrams

EF08M/10NB - EF08M/20NB
 pressure drop vs. flow

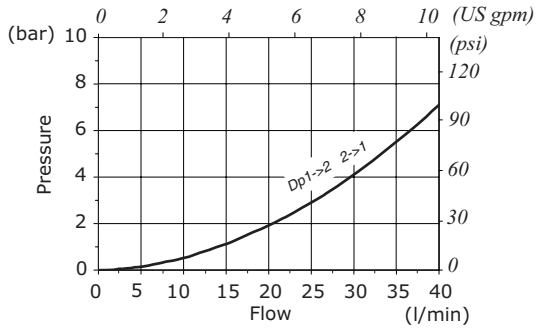

EF10M/10NB - EF10M/20NB
 pressure drop vs. flow

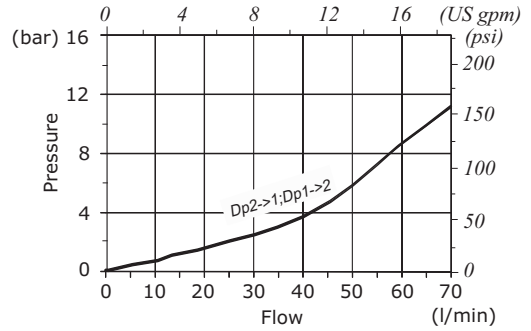

EF12M/10NB - EF16M/10NB
 pressure drop vs. flow

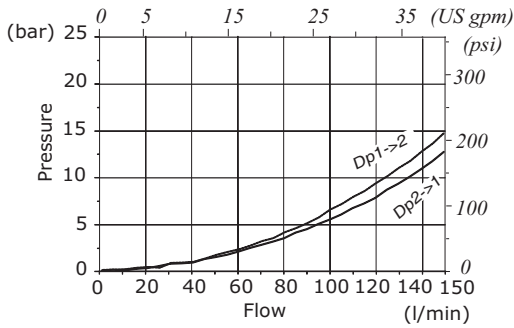

EF12M/20NB - EF16M/20NB
 pressure drop vs. flow

