



## Harnesses

- Dedicated to predefined PHC systems
- Power-line connection with fuse protection
- Suitable for static or fixed installation

### Working conditions

#### General features

Working temperature		from -30°C to 105°C ( <i>from -22°F to 221°F</i> )
Working features		fixed laying, motor, agricultural and civil environment
Electrical insulation	rule	CEI 20-11, R3 type
	directive	2000/53/CE
Conductor section		DIN 72551-6, A and B type
Max. load current (continuative)	AWG22	up to 1 A
	AWG20	up to 2.5 A
	AWG17	up to 5 A
	AWG15	up to 10 A
	AWG13	up to 20 A

## KCD04-PHC400F

### Dimensions and wiring

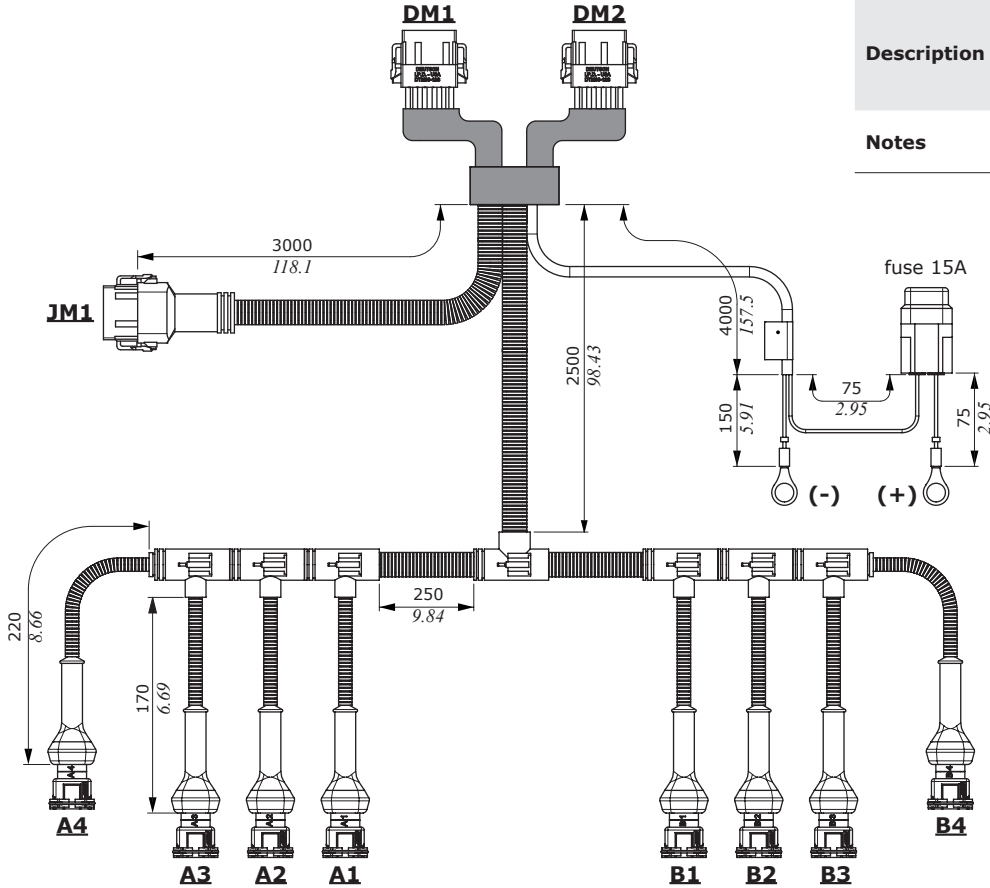

#### KCD04-PHC400F harness

<b>Code</b>	<b>183480118</b>
<b>Description</b>	KCD04/(D2M12-D2M12)-01D2M12300(TC)-02(4)T1F02300(TC)-03(4)T102300(TC)-AU1F15400(TC)
<b>Notes</b>	AJW and CED400W connection, for 4 proportional functions

#### Electrical wiring

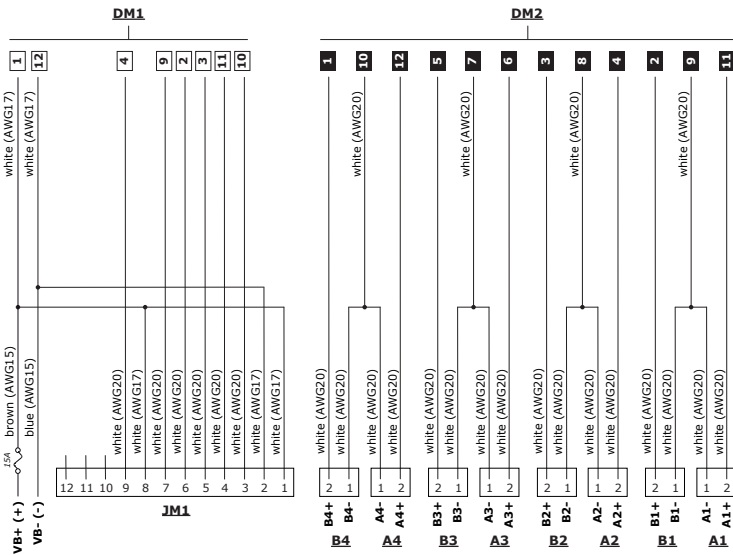

Connector types		
ID	Connection to	Type
<b>DM1</b>	CED	DTM06-12SA Deutsch
<b>DM2</b>	CED	DTM06-12SB Deutsch
<b>JM1</b>	Joystick	DTM06-12SA Deutsch
<b>A1 to B4</b>	proportional solenoid valves	AMP JPT, 2 poles

Connector PIN-OUT					
Pin	DM1 connector		DM2 connector		JM1 conn.
	Name	Function	Name	Function	Function
<b>1</b>	VB+	VB+	OUT_8	B4+	VJ+
<b>2</b>	AI_4	joystick 4	OUT_2	B1+	VJ-
<b>3</b>	AI_3	joystick 3	OUT_4	B2+	joystick 1
<b>4</b>	DI_1	dead man	OUT_3	A2+	joystick 2
<b>5</b>	plugged	plugged	OUT_6	B3+	joystick 3
<b>6</b>	plugged	plugged	OUT_5	A3+	joystick 4
<b>7</b>	plugged	plugged	GND_3	A3- / B3-	float
<b>8</b>	plugged	plugged	GND_2	A2- / B2-	VJ+
<b>9</b>	DI_2	float	GND_1	A1- / B1-	dead man
<b>10</b>	AI_1	joystick 1	GND_4	A4- / B4-	plugged
<b>11</b>	AI_2	joystick 2	OUT_1	A1+	plugged
<b>12</b>	VB-	VB-	OUT_7	A4+	plugged

### Dimensions and wiring

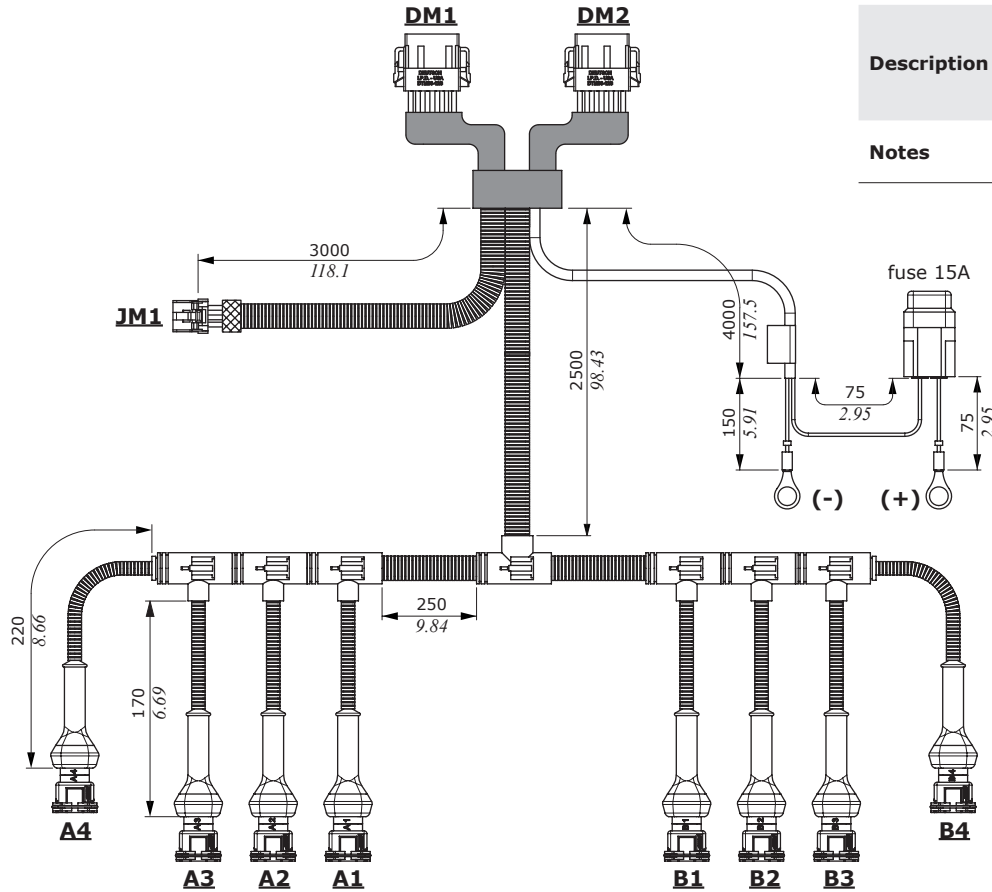

#### KCD04-PHC400C harness

**Code** 183480168

**Description** KCD04/(D2M12-D2M12)-01A8M12300(TC)-02(4)T1F02300(TC)-03(4)T102300(TC)-AU1F15400(TC)

**Notes** CJW and CED400W connection, for 4 proportional functions

### Electrical wiring

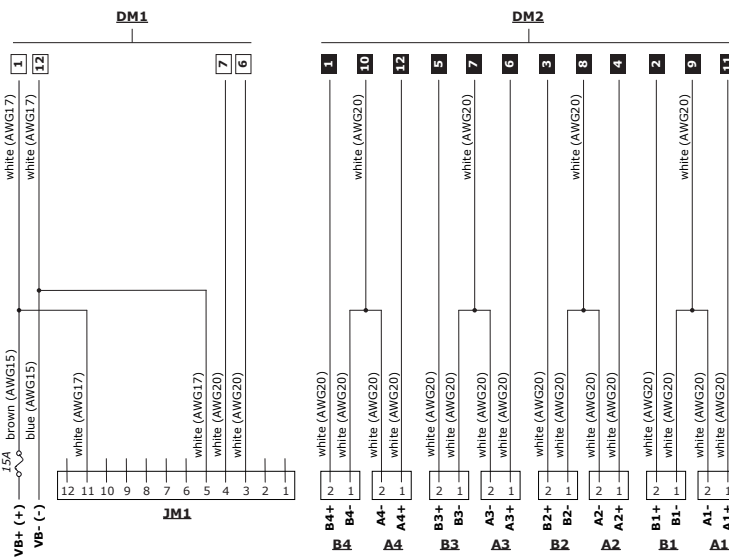

#### Connector types

ID	Connection to	Type
DM1	CED	DTM06-12SA Deutsch
DM2	CED	DTM06-12SB Deutsch
JM1	Joystick	Multilock Series 040 Tyco, 12 poles
A1 - B4	Proportional solenoid valves	JPT AMP, 2 poles

#### Connector PIN-OUT

Pin	DM1 connector		DM2 connector		JM1 con.
	Name	Function	Name	Function	Function
1	VB+	VB+	OUT_8	B4+	not conn.
2	plugged	plugged	OUT_2	B1+	not conn.
3	plugged	plugged	OUT_4	B2+	CAN_L
4	plugged	plugged	OUT_3	A2+	CAN_H
5	plugged	plugged	OUT_6	B3+	VJ-
6	CAN_L	CAN_L	OUT_5	A3+	not conn.
7	CAN_H	CAN_H	GND_3	A3- / B3-	not conn.
8	plugged	plugged	GND_2	A2- / B2-	not conn.
9	plugged	plugged	GND_1	A1- / B1-	not conn.
10	plugged	plugged	GND_4	A4- / B4-	not conn.
11	plugged	plugged	OUT_1	A1+	VJ+
12	VB-	VB-	OUT_7	A4+	not conn.

## KCD02-PHC400

### Dimensions and wiring

#### KCD02-PHC400 harness

**Code** 183480203

**Description** KCD02/D2M12-01(4)-T1F02300(TC)-03M2M04344(TC)-02(4)-T1F02300(TC)

**Notes** CED400W connection, for 4 proportional functions

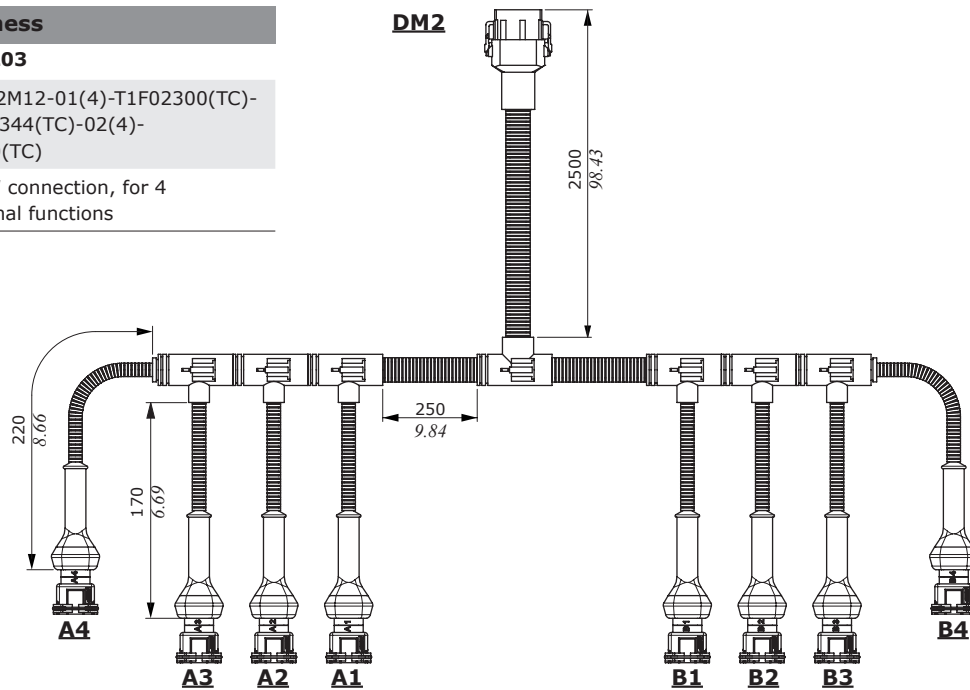

### Electrical wiring

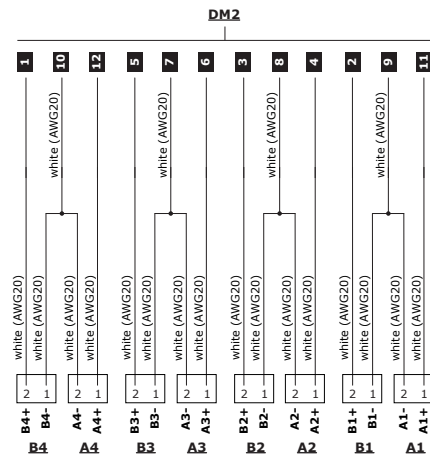

Connectors		
Name	Connection to	Type
DM2	CED	DTM06-12SB Deutsch
A1 - B4	Proportional solenoid valves	AMP JPT, 2 poles

PIN-OUT connectors		
Pin	Connector DM2	
	Nome	Function
1	OUT_8	B4+
2	OUT_2	B1+
3	OUT_4	B2+
4	OUT_3	A2+
5	OUT_6	B3+
6	OUT_5	A3+
7	GND_3	A3- / B3-
8	GND_2	A2- / B2-
9	GND_1	A1- / B1-
10	GND_4	A4- / B4-
11	OUT_1	A1+
12	OUT_7	A4+

## PHC400 load extension cable

### Dimensions and features

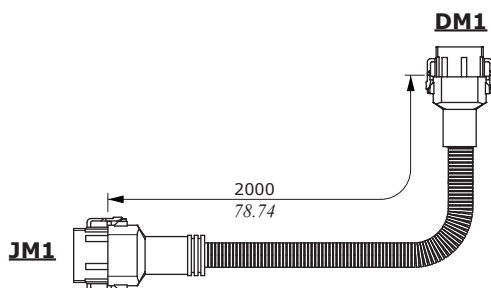

Connectors		
Name	Connection to	Type
DM1	CED	DTM06-12SB Deutsch
JM1	joystick	DTM06-12SB Deutsch

#### Load extension cable harnesses

**Code** 183490049

**Description** D2F12-D2M12 L=2000

**Notes** CED400W connection

### Dimensions and wiring

#### KCD05-PHC220C harness

**Code** 183480165

**Description** KCD05/D2M06-01CCF07600(TC)-02M2M04344(TC)-03M2M04344(TC)-AU2F15734(TC)-AU1730(TC)

**Notes** CJW connection to EME mechatronic modules, for 2 proportional functions

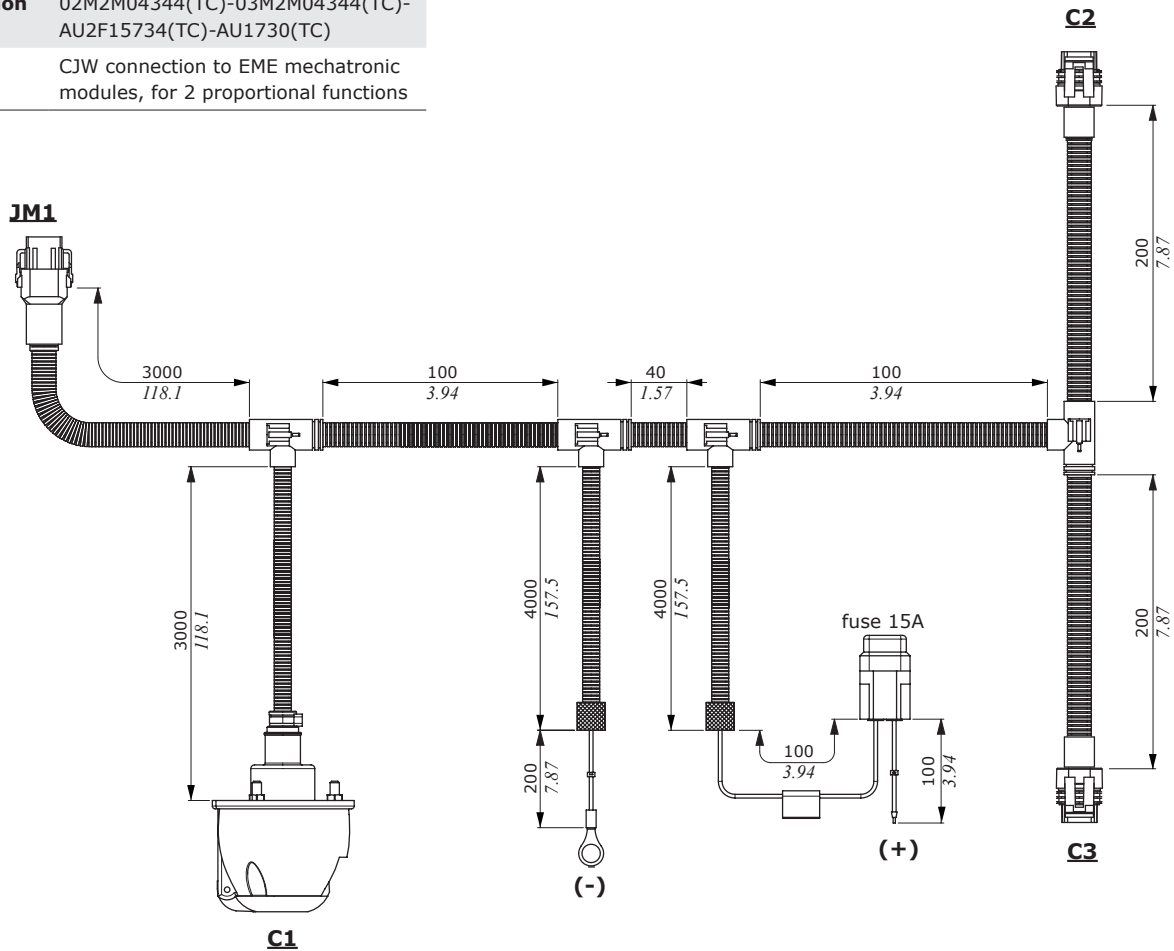

#### Electrical wiring

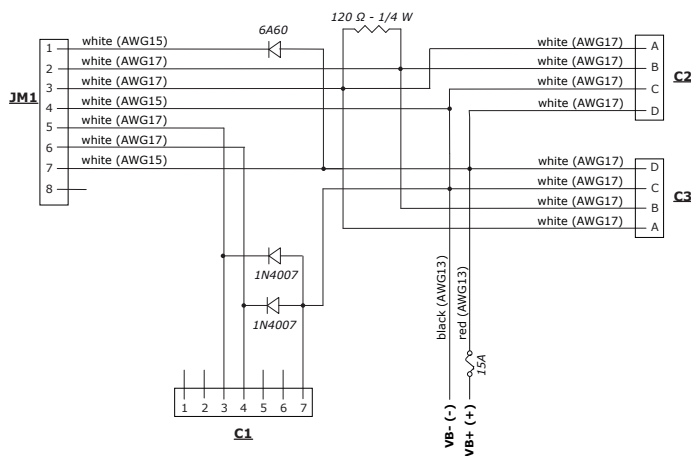

#### Connector types

ID	Connection to	Type
C1	ON/OFF valves	8JB001941002 Hella
JM1	Joystick	DTM06-8S Deutsch
C2+C3	Mechatronic modules	M-PACK150_2 Packard, 4 poles

#### Connectors PIN-OUT

Pin	Functions		
	C1 conn.	JM1 conn.	C2+C3 conn.
1	not connected	VJ+	CAN_H
2	not connected	CAN_L	CAN_L
3	ON-OFF 3	CAN_H	VB-
4	ON-OFF 4	VB-	VB+
5	plugged	ON-OFF 3	/
6	plugged	ON-OFF 4	/
7	VB-	VJ+	/
8	/	plugged	/

## KCD05-PHC250C

### Dimensions and wiring

#### KCD05-PHC250C harness

**Code** 183480166

**Description** KCD06/(D2M12-D2M12)-01F1F05330(TC)-02CCF07320(TC)-03M2M04350(TC)-04M2M04350(TC)-AU2F15250(TC)-AU1250(TC)

**Note** CJW, CED040 and EME mechatronic modules connection, for 2 proportional functions

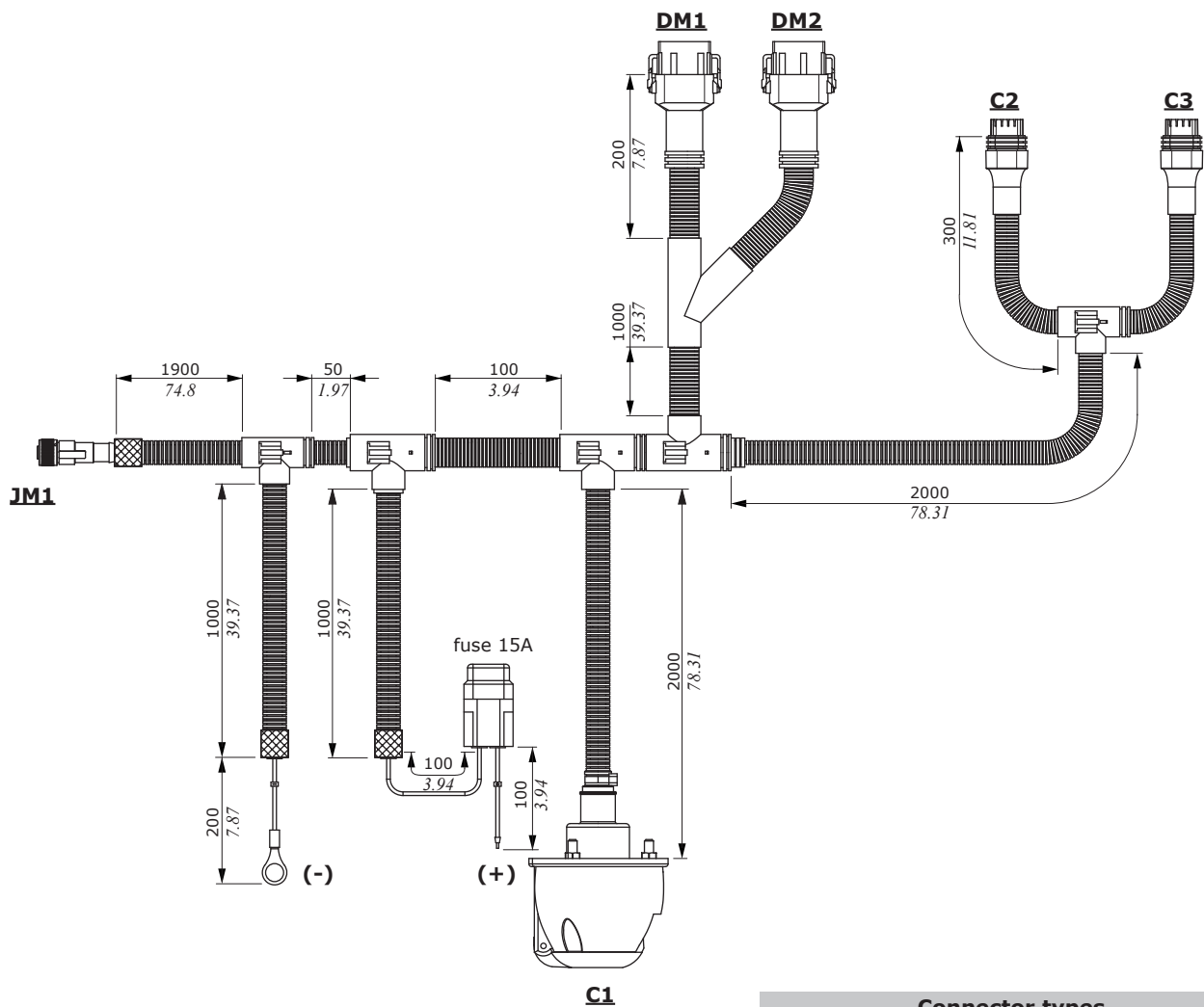

Connector types		
ID	Connection to	Type
<b>DM1</b>	CED	DTM06-12SA Deutsch
<b>DM2</b>	CED	DTM06-12SB Deutsch
<b>JM1</b>	Joystick	5 poles M12 - female
<b>C1</b>	ON/OFF valves	8JB001941002 Hella
<b>C2+C3</b>	Mechatronic modules	M-PACK150_2 Packard, 4 poles

### Dimensions and wiring

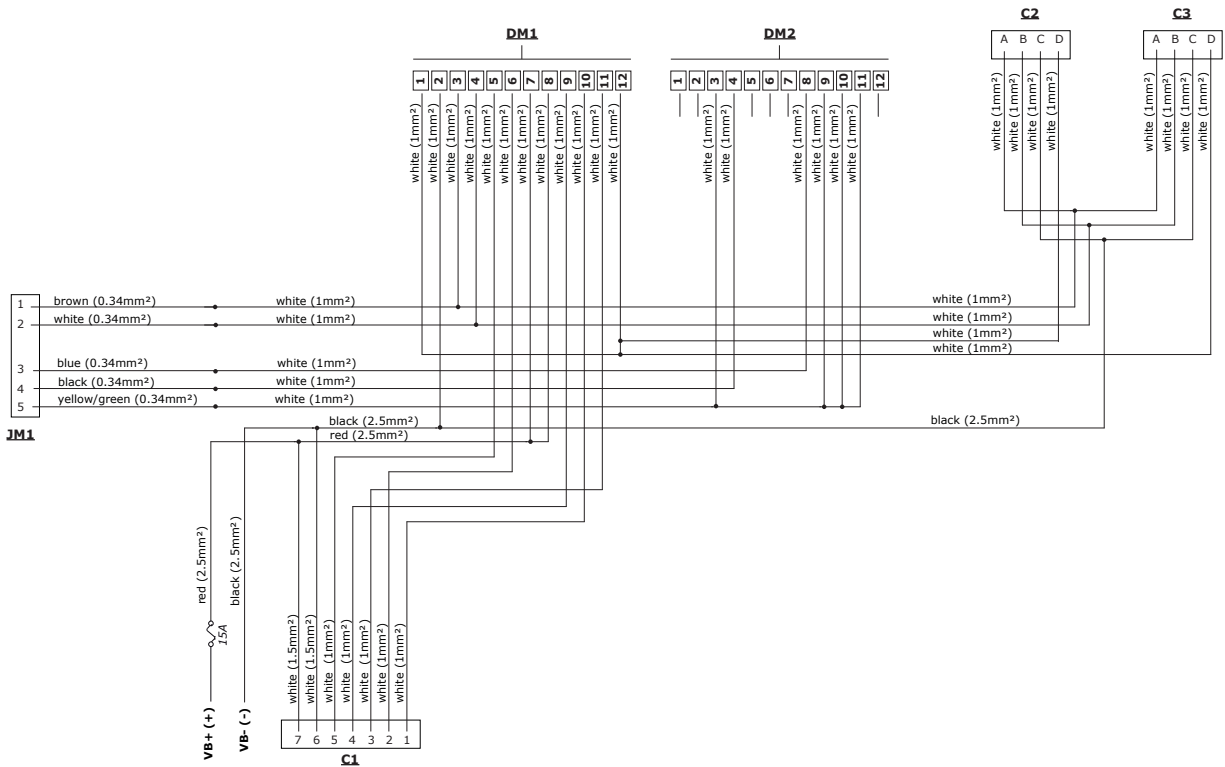

**Connectors PIN-OUT**

Pin	DM1 connector		DM2 connector		JM1 conn.	C1 conn.	C2+C3 con.
	Name	Function	Name	Function	Function	Function	Function
1	OUT_1	VEME+	OUT_L	plugged	CAN_H	ON-OFF 3	CAN_H
2	VB-	VB-	DI_5	plugged	CAN_L	sensor 2	CAN_L
3	CAN_H	CAN_H	DI_1	VK+	VJ+	ON-OFF 1	VB-
4	CAN_L	CAN_L	VJ-	VJ-	VJ-	ON-OFF 2	VEME+
5	AI_6	sensor 1	AI_3	plugged	VK+	sensor 1	/
6	AI_7	sensor 2	AI_2	plugged	/	VB-	/
7	VK+	VB+	AI_1	plugged	/	VB+	/
8	VK+	VB+	VJ+	VJ+	/	/	/
9	OUT_2	ON-OFF 2	DI_2	VK+	/	/	/
10	OUT_3	ON-OFF 3	DI_3	VK+	/	/	/
11	OUT_4	ON-OFF 1	DI_4	VK+	/	/	/
12	OUT_1	VEME+	DI_6	plugged	/	/	/

## KCD10-PHC251C

### Dimensions and wiring

#### KCD10-PHC251C harness

**Code** 183480137

**Description**

KCD10/CD3F40-01T1F02025-02T1F02025-03T1F02025-04T1F02025-05T1F02025(TAP)-06CCF07090(TC)-07F105050(TC)-08A1M03025(TAP)-AU2F15300(TC)-AU1300(TC)

**Note**

CJW and CED252 connection, for 2 proportional functions

**Code** 183490001

**Description**

F1M05-F1F05(TC) L=4m (157.48 in)

**Note**

extension for CJW connection

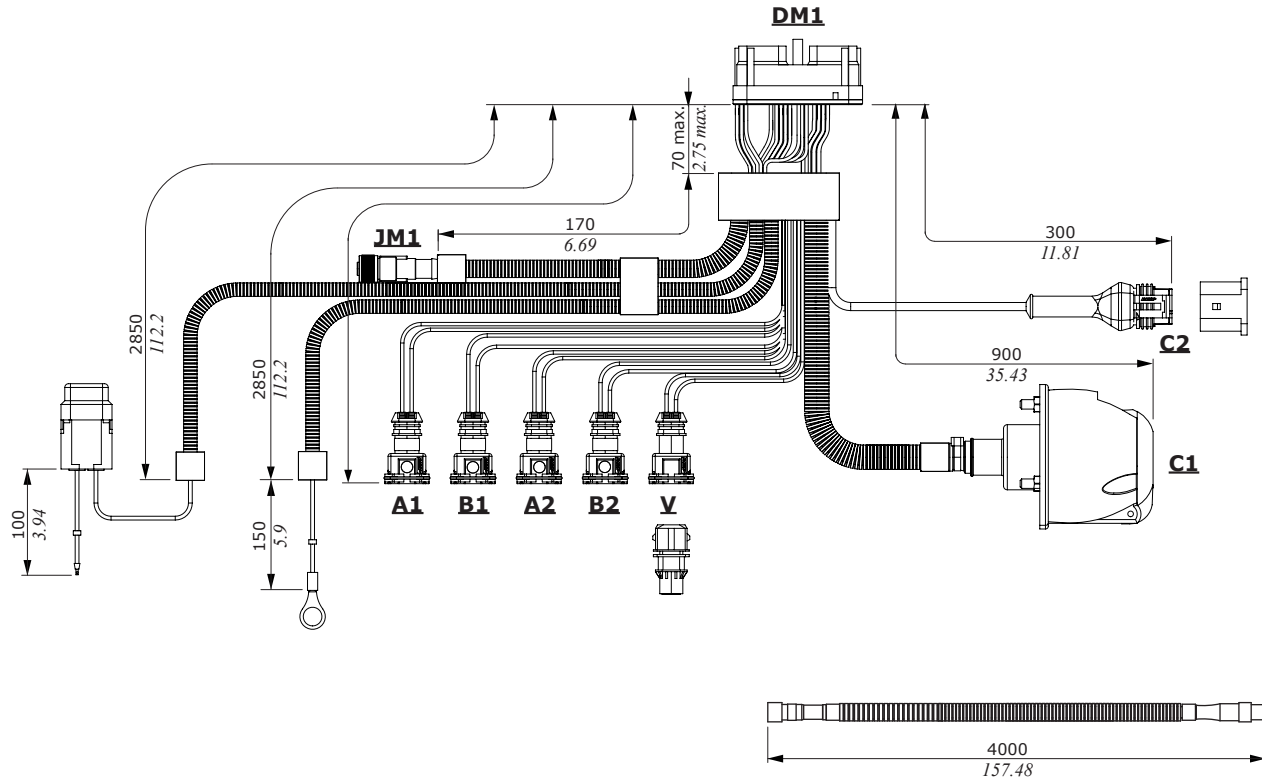

Connector types		
ID	Connection to	Type
DM1	CED	DRC26-40SA Deutsch
JM1	Joystick	5 poles M12 - female
C1	ON/OFF valves	8JB001941002 Hella
C2	programming	Superseal AMP, 3 poles, male
A1-B1	proportional solenoid valves	JPT AMP, 2 poles
A2-B2		
V		



### Dimensions and wiring

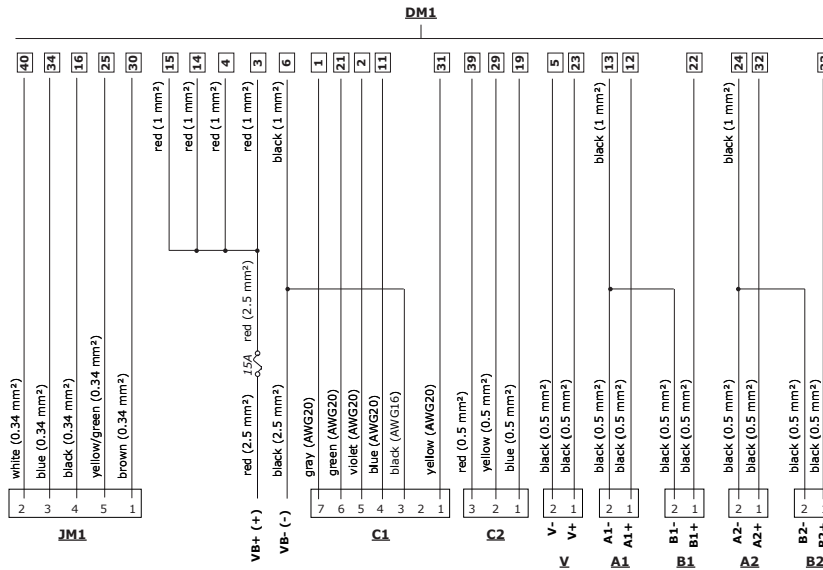

Connectors PIN-OUT			
Pin	JM1 conn. Function	C1 conn. Function	C2 conn. Function
1	CAN_H	diverter 2	RS232-GND
2	CAN_L	/	RS232-Tx
3	VJ+	power GND	RS232-Rx
4	VJ-	diverter 1	/
5	EM-SW	diverter 3	/
6	/	diverter 4	/
7	/	diverter 5	/

DM1 connector PIN-OUT											
Pin	Name	Function	Pin	Name	Function	Pin	Name	Function	Pin	Name	Function
1	OUT_8	diverter 5	11	OUT_7	diverter 1	21	OUT_10	diverter 4	31	OUT_6	diverter 2
2	OUT_9	diverter 3	12	OUT_1	A1+	22	OUT_2	B1+	32	OUT_3	A2+
3	VK+	VK+	13	GND_1	A1- / B1-	23	OUT_5	V+	33	OUT_4	B2+
4	VK+	VK+	14	VK+	VK+	24	GND_2	A2- / B2-	34	VJ+	VJ+
5	GND_3	V-	15	VB+	VB+	25	VEM+	EM-SW	35	VS+	not conn.
6	VB-	GND	16	VJ-	VJ-	26	AI_11	not conn.	36	AI_1	not conn.
7	AI_3	not conn.	17	AI_2	not conn.	27	AI_8	not conn.	37	AI_5	not conn.
8	AI_6	not conn.	18	AI_7	not conn.	28	AI_4	not conn.	38	AI_9	not conn.
9	AI_10	not conn.	19	GND	RS232-GND	29	RX	RS232-Rx	39	TX	RS232-Tx
10	VS-	not conn.	20	CAN_SH	not conn.	30	CAN_H	CAN_H	40	CAN_L	CAN_L

## KCD03+KCD03-PHC640C

### Dimensions and wiring

#### KCD03+KCD03-PHC640C harness

**Code** 183480169

**Description**

KCD03/D2M12(2)-D2M12(2)-01(8)  
T1F02160(TC)-02(8)T1F02160(TC)-  
03CI10M380(TC)+KCD03/CI10F-  
01A8M12350(TC)-02A8M12350(TC)-  
AU1F15300

**Notes**

CJW and CED400W connection, for 8  
proportional functions

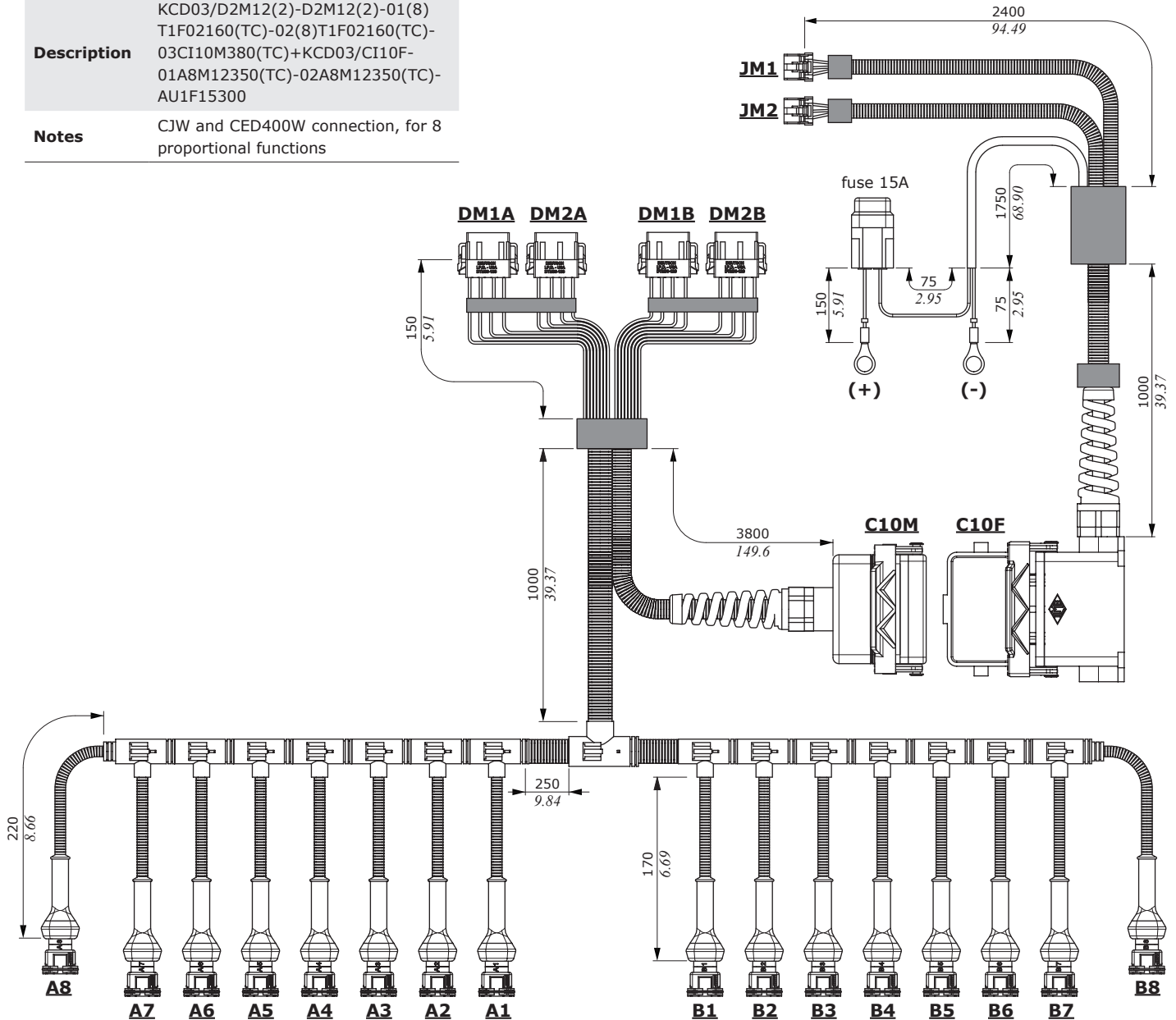

Connector types		
ID	Connection to	Type
<b>DM1A+DM1B</b>	CED	DTM06-12SA Deutsch
<b>DM2A+DM2B</b>	CED	DTM06-12SB Deutsch
<b>C10M</b>	cable extension	CNM10+CHV10L+CHC10LG Ilme
<b>C10F</b>	cable extension	CNF10+CHP10LS Ilme
<b>JM1+JM2</b>	joystick	Multilock 040 series Tyco, 12 poles
<b>A1 to B8</b>	proportional solenoid valves	JPT AMP, 2 poles

### Dimensions and wiring

- 1** DM1A connector
- 1** DM2A connector
- 1** DM1B connector
- 1** DM2B connector

### Electrical wiring

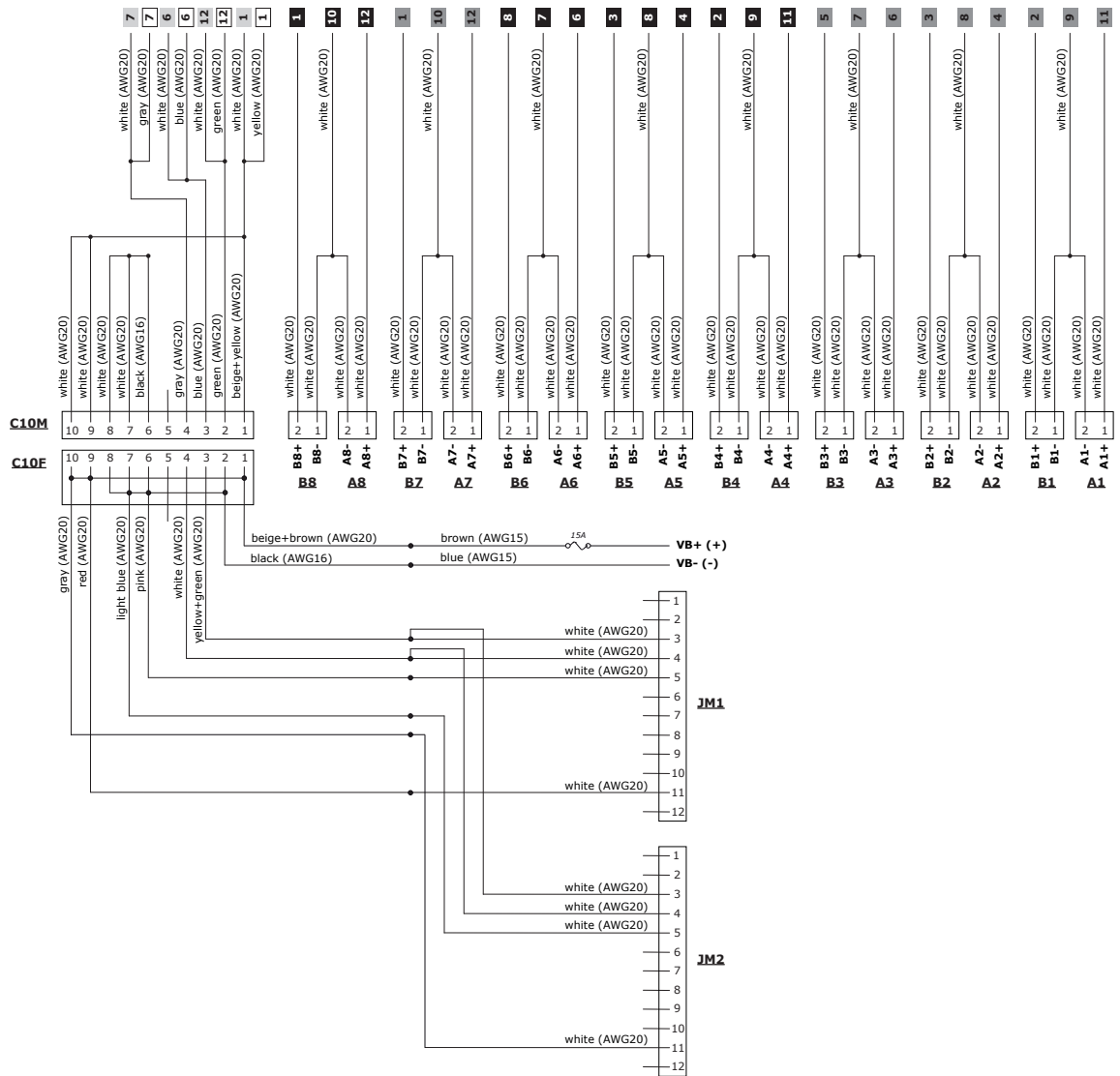

### Connector PIN-OUT

Pin	DM1A connector		DM2A connector		DM1B connector		DM2B connector		JM1+JM2 con.	C10M+C10F con.
	Name	Function	Name	Function	Name	Function	Name	Function		
1	VB+	VB+	OUT_8	B7+	VB+	VB+	OUT_8	B8+	not connected	VB+
2	plugged	plugged	OUT_2	B1+	plugged	plugged	OUT_2	B4+	not connected	VB-
3	plugged	plugged	OUT_4	B2+	plugged	plugged	OUT_4	B5+	CAN_L	CAN_L
4	plugged	plugged	OUT_3	A2+	plugged	plugged	OUT_3	A5+	CAN_H	CAN_H
5	plugged	plugged	OUT_6	B3+	plugged	plugged	OUT_6	B6+	VJ-	not connected
6	CAN_L	CAN_L	OUT_5	A3- / B3-	CAN_L	CAN_L	OUT_5	A6+	not connected	VB-
7	CAN_H	CAN_H	GND_3	A3- / B2-	CAN_H	CAN_H	GND_3	A6- / B6-	not connected	VB-
8	plugged	plugged	GND_2	A2- / B1-	plugged	plugged	GND_2	A5- / B5-	not connected	VB-
9	plugged	plugged	GND_1	A1- / B1-	plugged	plugged	GND_1	A4- / B4-	not connected	VJ+
10	plugged	plugged	GND_4	A7- / B7-	plugged	plugged	GND_4	A8- / B8-	not connected	VJ+
11	plugged	plugged	OUT_1	A1+	plugged	plugged	OUT_1	A4+	VJ+	/
12	VB-	VB-	OUT_7	A7+	VB-	VB-	OUT_7	A8+	VJ-	/